

# REDSTONE Stage One





# REDSTONE Requirements

## **1. THE WRITTEN PHASE**

The cadet must successfully pass a written examination on rocket history and the lives of rocket pioneers.

## **2. THE OFFICIAL WITNESS LOG (OWL) AND TESTING**

The cadet must have the Squadron Testing Officer (STO) administer the written examination and sign the Official Witness Log (OWL) after a successful score is achieved by the cadet.

## **3. THE HANDS-ON PHASE**

The cadet is required to build two non-solid fuel rockets, with alternate sources of power. There are four options in this text; the cadet must complete two.

## **4. THE OFFICIAL WITNESS LOG (OWL) AND MODEL ROCKET FLIGHTS**

The cadet must have a Qualified Senior Member (QSM) witness the successful launch of the two models built with alternate sources of power.

## **5. THE SQUADRON COMMANDER**

After completion of all the above requirements, the cadet is entitled to the Redstone certificate. The Squadron Commander must review the completed Official Witness Logs and sign this certificate so the cadet may advance to the Titan stage. It is recommended that the certificate be presented at a squadron awards ceremony.

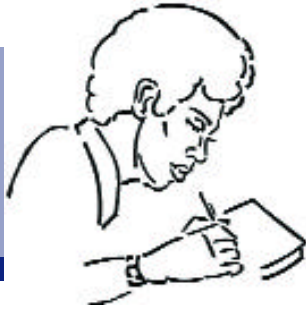

# REDSTONE Written Phase

## A BRIEF HISTORY OF ROCKETRY AND ITS GREAT PIONEERS

Perhaps the first true rockets were "accidents!" In the first century AD the Chinese were reported to have experimented with a simple explosive powder made from saltpeter, sulfur and charcoal. Although these powders were used to create small explosions in religious festivals, they eventually ended up in a weapon. The Chinese would fill bamboo tubes with this mixture and attach them to arrows. These "fire arrows," as they were called, were used at the battle of Kai-Keng where the Chinese repelled the Mongol invaders with a "rocket barrage." This occurred in the year 1232.

Much later, in 1405, a German engineer by the name of Konrad Kyeser von Eichstadt devised a rocket that was propelled by gunpowder. Another European country, France, used rockets to defend Orleans against the British in 1429 and again at the siege of Pont-Andemer in 1449.

During the Thirty Year War (1618-1648) rockets weighing as much as 100 pounds were fired. These exploded and sent small pieces of shrapnel in all directions. Rockets were extensively used in India when they were fired at the British in the battles of Seringapatam (1792 and 1799).

During the latter part of the 17th century the scientific foundations for modern rocketry were laid by Sir Isaac Newton, a great British scientist. Newton organized his understanding of physical motion into three scientific laws (covered in the Titan Stage of this text). Newton's laws soon began to have a practical impact upon the design of rockets in those days. During the 18th century, rockets experienced a brief revival as a weapon of war. India used rockets with great success against the British in 1792 and this caused Colonel William Congreve, a British artillery expert, to start using more of a scientific approach to the development of sophisticated rockets. He standardized the composition for gunpowder explosives and then added flight-stabilizing guide sticks. Congreve was able to increase the rocket's range from approximately 300 to over 3000 yards. Approximately 25,000 Congreve rockets were used in 1807 at the battle of Copenhagen.

In the War of 1812 between Britain and the United

States, the British used rockets against the U.S. troops. During a typical siege the rockets would light up the night sky and in the battle at Fort McHenry, in 1812, Francis Scott Key witnessed the display. This inspired him to write a poem which later became part of America's National Anthem, the "Star Spangled Banner."

Even with William Congreve's technological developments the accuracy of rockets still left much to be desired. William Hale, an Englishman, developed a technique called spin stabilization. In this technology, the escaping exhaust gases struck small vanes at the bottom of the rocket, causing it to spin like a bullet in flight. This gave the rocket much greater stability and accuracy.

Even with improvements in stabilization the rocket was never used as a major military weapon until the 20th century. Standard artillery was much more widely used because of the superior accuracy of a cannon projectile for hitting a specific target.

By the end of the 19th century, men were beginning to dream of traveling into space and reaching other planets. To accomplish such a feat required a machine that had great power and speed. At first, the scientific community scoffed at the idea of space flight, but a few brave scientists continued to dream and even develop experiments using rocket power.

## FOUR OF THE GREAT ROCKET PIONEERS

### Konstatin Eduardovich Tsiolkovsky (1857-1935)

Tsiolkovsky was a Russian teacher who made some of the first mathematical computations for rocket flights into space. He was born in Izhevskoe, Russia, and was the 5th of 18 children. His father was a forester by trade.





**Konstatin Eduardovich Tsiolkovsky**

He was a visionary and is still considered by his countrymen to be the first scientist to lay the foundation for space exploration. At the age of ten, he came down with scarlet fever and was handicapped with near total deafness for the rest of his life. This disability forced him to turn inward and he developed a lifelong passion for books. The hearing impairment forced him to leave public education, and it was then young Konstatin decided to educate himself at home. In the early 1870's, his family recognized the boy's brilliance and sent him to Moscow to study. Here he met Nikolai Fedorov, an eccentric philosopher who shared his radical theories on "cosmism." This relationship had a profound effect on the future thinking of the young Tsiolkovsky. Historians agree that Nikolai Fedorov's theories inspired Tsiolkovsky's interest in space flight. In his quest to read everything about the subject, he discovered the novels of Jules Verne and was especially fascinated with the novel *Earth To The Moon* (1865).

He decided to try his own luck at writing science fiction and his work reflected technical expertise that was based on real science, not fantasy. This included such previously unknown concepts such as microgravity, space suits and control of a rocket outside the atmosphere.

Years of study paid off when Tsiolkovsky passed the examination to become a certified teacher. He moved to the town of Borovsk where he was assigned to teach mathematics. During this period, he met and married Varvara Sokolova in 1880. Over the next few years, the teacher-scientist wrote a piece titled *Svobodnoe Prostranstvo* or "Free Space." It was never published during his lifetime, but was later put into print in the mid-

twentieth century. In this historic text he spoke of vacuum, weightlessness and many of the other dangers facing future space voyagers. He also talked about using gyroscopes to control the orientation of a spacecraft.

In 1903, Tsiolkovsky published an article titled "*The Exploration of the World Space with Jet Propulsion Instruments*" in *Nauchnoe Obozrenie* (Scientific Review) magazine. Experts now recognize this as being the first true, scientifically-based proposal for space exploration. In the article, he formulated relationships between the changing mass of a rocket as it burned fuel, the velocity of exhaust gases and the rocket's final velocity. His work also included, and illustrated, a rocket engine that was fueled by liquid hydrogen and oxygen, a fuel combination that is used to this day in the Space Shuttle. In later works, he spoke of multi-stage rockets, rocket-powered airplanes, an orbiting space station and eventually colonization of the galaxy.

Although he never built an actual rocket, he did lay much of the groundwork in theoretical aerospace engineering. He was a humble teacher who is, today, held in the highest regard by the people of Russia. He is recognized as the **Father of Space Travel**.

## **Hermann Oberth (1894-1989)**

Hermann Julius Oberth was born on June 25, 1894 in the town of Hermannstadt, Transylvania. In some circles he too is given the title of "Father of Space Travel." His interest in rocketry started in 1905 when he was 11 years old. Once again the book *From the Earth To The Moon*, by Jules Verne, excited his imagination about the possibilities of manned space exploration. After careful study, Oberth realized that many of the "fantasies" found in the book, had sound scientific principles behind them. By age 14, Oberth theorized that a "recoil rocket"



**Hermann Oberth**

that could travel through space by the expulsion of exhaust gases.

As a student in college, he found that it was not much of a challenge. However, when he reached graduate school, and was working on his doctoral degree, he found many challenges and immersed himself in science. It was during this time that he wrote a thesis on the development of a rocket. This work, published in 1923, was titled *The Rocket into Planetary Space*. At first, it was rejected by the scientific community. In this book, Oberth covered concepts such as a rocket's fuel consumption, fuel handling hazards, the dangers of working with solid propellants and the possible hazards to humans. He also reasoned that as a rocket flies higher and higher, the mass of the propellant becomes less while the mass of the rocket remains unchanged. In relative terms, this means that the rocket becomes heavier in relation to the engine's ability to provide thrust. It was this thinking that gave Oberth the idea of multi-staging. When the first stage fuel is burned off, that stage should be discarded. Needless to say, that idea is still in use today.

In the thirties, Oberth developed a close working relationship with Werner von Braun. They worked together on the development of the infamous V2, or Vengeance Weapon, for the German Army. Later, after World War II, the two, von Braun and Oberth, worked at the United States' Army Ballistic Missile Agency in Huntsville, Alabama.

Hermann Oberth, a great pioneer in the field of astronautics, died in West Germany on December 29th, 1989, at the age of 95. He made an enormous contribution to mankind's space exploration.

## **Robert H. Goddard (1882-1945)**

Dr. Robert Goddard is considered to be the father of practical modern rocketry. Robert's father was a great believer in education and encouraged his son to experiment with things. Robert and his father spent many hours hiking through the woods studying nature. He had a telescope and while still in primary school, developed an interest in space.

Goddard eventually entered Clark University and majored in the sciences. This allowed him an opportunity to put his scientific knowledge to work with rocket experimentation. As a graduate student, Robert worked closely with a nationally-known physicist, Dr. Gordon A. Webster. This association gave him an extensive background in the sciences. He eventually earned his PhD. and was hired by Clark University as a faculty member.

After a long period of experimentation, Goddard built a successful liquid-fuel rocket that was launched on March 16, 1926, from a field near the city of Worcester,



**Robert H. Goddard**

Massachusetts. Although the rocket flew for just 2.5 seconds and rose to a height of only 41 feet, it proved that liquid-fuel rockets worked. One of the great advantages of liquid-fuel is that it can be controlled, whereas, solid-fuel burns to completion once ignited.

During World War I, Goddard received a grant from the U.S. Army to work on solid fuel rocket projects. One invention, developed during this time, was a three-inch rocket fired through a steel tube. This later evolved into the well-known anti-tank bazooka that was so widely used in World War II.

In the 20s, Goddard's rocket experiments caught the attention of the media. In one of his papers, published by the Smithsonian Institution, he speculated on the eventual travel to the moon using high-powered rockets. Unfortunately, he was ridiculed by the press and this caused him to continue most of his later experiments in secret.

Goddard and his wife, Ester, eventually moved to Roswell, New Mexico, where he conducted experiments without the humiliation of the news media. Much of his work was funded by the Guggenheim Foundation and was even witnessed by Charles A. Lindbergh, world famous aviator. Although not recognized as being a scientist of any significance in the United States, his work was seen as very important by scientists in Germany who were preparing for war in Europe.

His experiments included fuel feeding devices, propellant pumps, gyroscopic stabilizers, and instruments for monitoring the flight of rockets. Just before WWII, Dr. Goddard was hired to help develop rocket-powered, quick-takeoff propulsion units for U.S. Navy aircraft. In Germany, rocketry went forward with the development of higher-powered engines. These experiments eventually evolved into the infamous V-2 which was used as

intercontinental ballistic missiles against Great Britain.

After World War II, both the U.S. and Russia acquired German rocket scientists. These men formed the nucleus of a program that developed into the powerful launch vehicles used today.

## **DR. WERNER von BRAUN (1912-1977)**

Werner von Braun was one of the most important figures in the advancement of space exploration in aerospace history. As a youth, he was inspired, like many others, by the fictional works of Jules Verne and H.G. Wells. During his teen years, von Braun became involved in a German rocket society and used this connection to further his desire to build large rockets. He



**Werner von Braun**

was also a great follower of Hermann Oberth and worked with him in the thirties and during the development of German rocketry during World War II. He continued his college work and eventually received a PhD. in physics.

Werner von Braun was the team leader of a group that developed the V-2 ballistic missile for the Nazis during WWII. Today, there is still controversy over his role in the use of slave labor to build the highly successful rockets. The V-2 was incredible for its time and was eventually used in the rocket development program of the United States. The V-2 was 46 feet long, weighed 27,000 pounds and had a sophisticated, but reliable liq-

uid fuel propellant system. The rocket could fly at speeds in excess of 3,000 miles per hour and would deliver a 2,200-pound warhead to a distance of 500 miles from its launch site. Before the end of WWII, von Braun managed to get many of his top rocket scientists to surrender to the Americans. This enabled the U.S. to get most of the science and test vehicles from the Germans before the Russians.

For 15 years after the war, von Braun worked with the U.S. Army in the development of ballistic missiles. As part of the military operation, known as "Project Paperclip," von Braun and his team were sent to Fort Bliss, Texas, and did the experimental launch work at White Sands Proving Ground in New Mexico. Eventually, the team moved to the Redstone Arsenal near Huntsville, Alabama.

In 1960, the rocket center transferred from the Army to a newly established organization called NASA, or National Aeronautics and Space Administration. It was during this time that von Braun was given the task of developing the giant Saturn rockets. He was to become the chief architect of the Saturn V launch vehicle that propelled American astronauts to the moon.

He became one of the most prominent spokesmen of space exploration for the United States during the latter part of his career. In 1970, NASA asked him to move to Washington, D.C., to head up the strategic planning efforts of the Administration. He left Huntsville, Alabama, but in less than two years, retired from NASA and went to work for Fairchild Industries. He died in Alexandria, Virginia, on June 16, 1977.



**Rocket posters make great cadet bulletin board learning tools. This poster features many of the rockets that were the result of pioneering work of the scientists featured in this unit. It can be purchased from the Pitsco company for under \$10 and is titled as "Space Rockets." Pitsco's toll-free number is 1-800-835-0686 and item number is AA52715. Cadets left to right are Nathan Cuellar, Kyle Drumm and Alec Atwood, of the Valkyrie Squadron, Denver, Colorado.**



# REDSTONE Official Witness Log

## WRITTEN PHASE EXAMINATION

A cadet is required to have a basic knowledge of rocket history and the lives of aerospace pioneers Robert H. Goddard, Konstantin Tsiolkovsky, Werner von Braun and Hermann Oberth. Once the cadet has studied the text and feels ready, he/she must take an examination administered by the Squadron Testing Officer (STO). The minimum passing grade for this examination is 70%. Upon successful passage of this test, the cadet must have the STO sign this document.

CADET \_\_\_\_\_

of \_\_\_\_\_  
Squadron, has successfully passed the written examination required of the Redstone phase.

As the STO, I have administered the test and found that Cadet

\_\_\_\_\_ passed with a score that meets or exceeds the minimum requirements of the Redstone phase of the Model Rocketry achievement program.

\_\_\_\_\_  
STO





# REDSTONE

## Hands-on Option One

### THE FIZZY FLYER

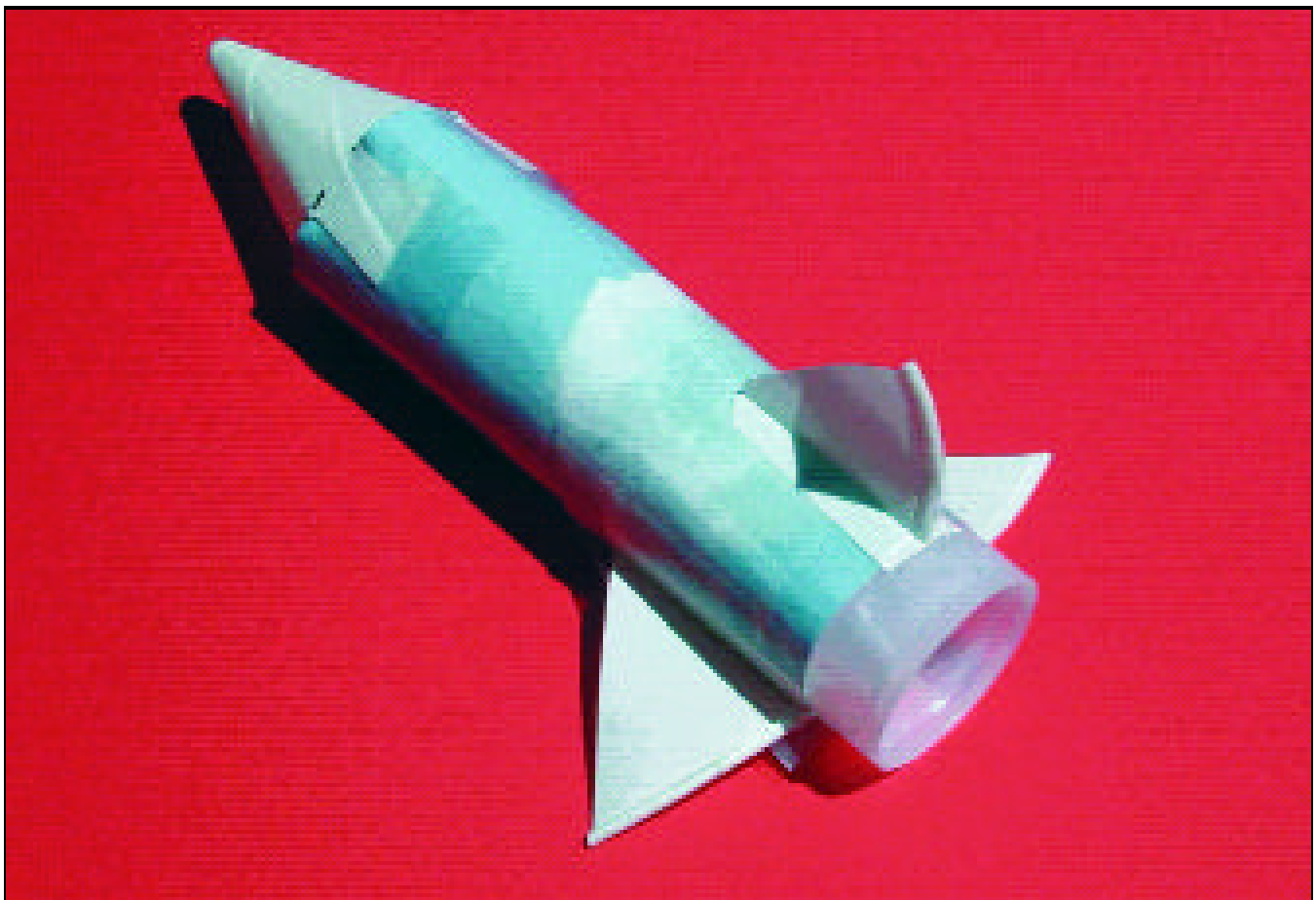

The Completed Rocket

**OBJECTIVE:** This “Fizzy Flyer” is designed to be an entry-level rocket. It is a rocket that is incredibly easy to build, incredibly cheap to operate, and incredibly fun for cadets.





**MATERIALS:**

1. 4" X 4" Piece of paper
2. 1 cone shaped paper drinking cup
3. tape
4. scissors
5. Alka Seltzer™ or other effervescent antacid tablet
6. 35mm film cannister with lid that fits inside cannister (see page 9)



**PROCEDURE:**

Cut a sheet of paper to 4" x 4". Apply tape to two sides of the paper as shown.



Remove lid from cannister and tape one edge to the open end about 1/2 inch up from opening.



Carefully wrap the paper around the cannister to form a tube. Press the remaining taped edge to seal the tube.



A common cone drinking cup is placed on top of the tube. By holding the cone and tube up to a light you will be able to see the top of the tube inside the cone and mark it as shown.



To attach the nose cone, leave little tabs so that you can tape it to the rocket's tubular body. The base of the drinking cup now becomes the rocket's nose cone.

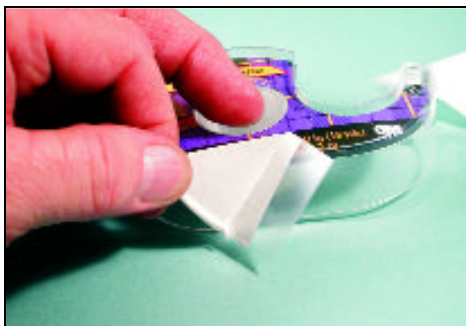

You can make tail fins from the remainder of the drinking cup, or from the remainder of the paper from which the tubular body was cut. Put tape on the fin as shown.



The fins are taped to the bottom of the rocket body next to the cannister opening as shown. This one was made from the remainder of the drinking cup.

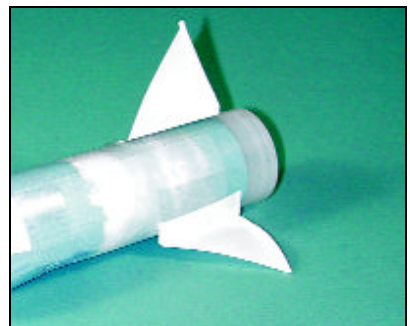

Tape 3 fins to the rocket base to make it more stable.

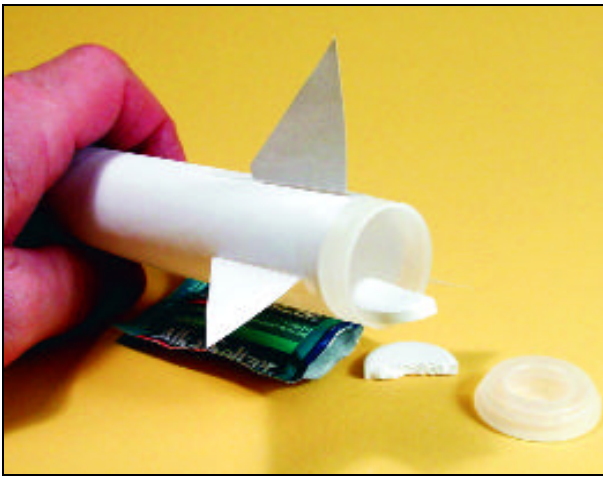

A trash bag on a table or the floor makes a good launch pad and easier clean-up.

You are now ready to load the "fuel." Hold the rocket nose down, pour in 1 teaspoon of water and drop in 1/2 Alka Seltzer™. Press on the cap and position the rocket on the trash bag and wait. Countdowns are fun but it's a little difficult to tell when the Fizzy Flyer is going to take off. But that's part of the fun.



4" x 4" Pattern  
for Body of Rocket

Fin Pattern  
Cut 3

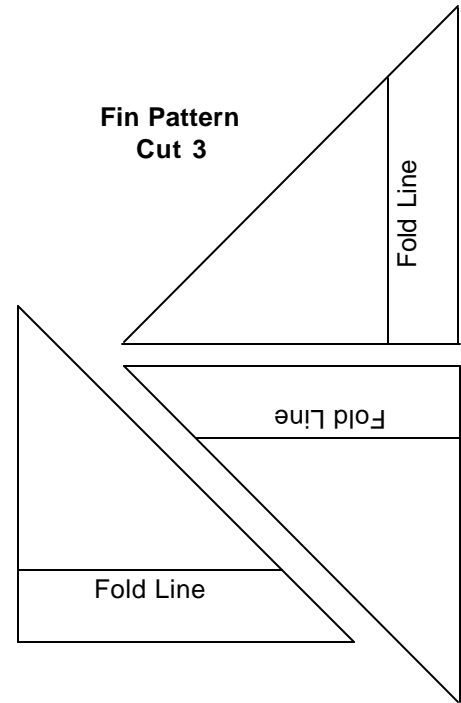

Tape the paper to the  
film canister here.

Put tape on  
two edges

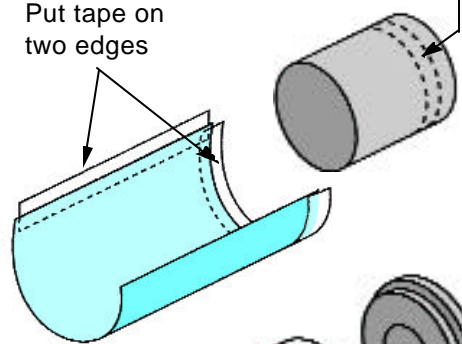

Lid that fits inside  
cannister

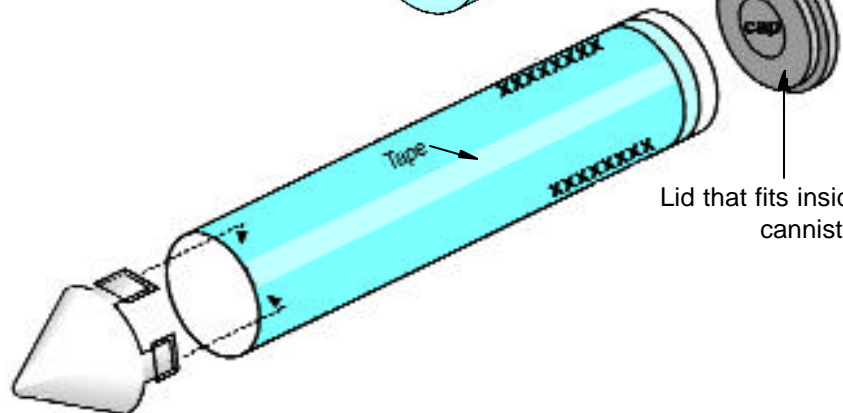

For better results, use heavy weight paper, approximately 60 lb. cover stock. It can be purchased at any office supply store.



# **REDSTONE**

## Hands-on Option Two

### **THE GODDARD ROCKET**

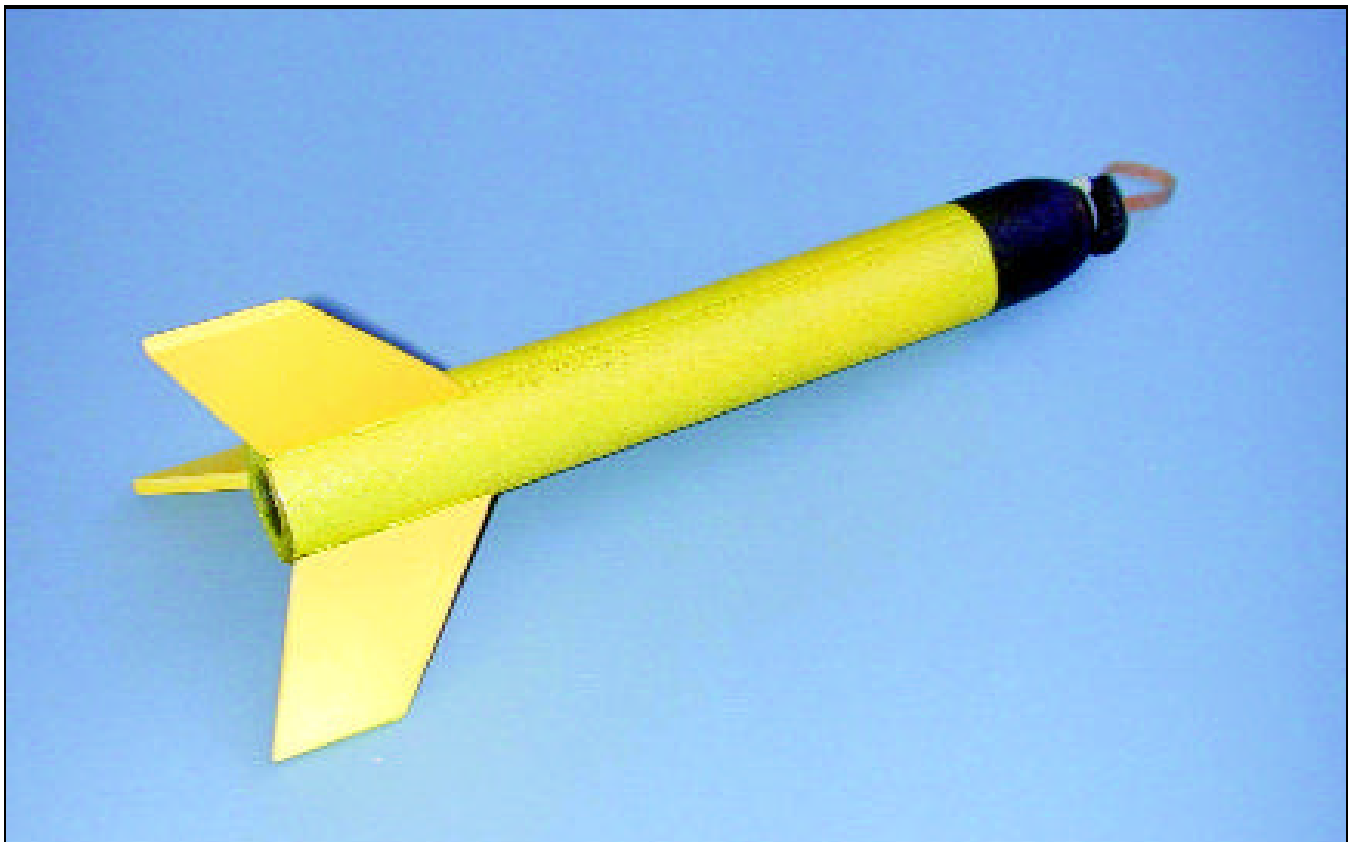

The completed Goddard Rocket - a foam rocket that can be built for a quarter!

**OBJECTIVE:** This activity allows cadets to build an inexpensive, safe, flying model of a rocket.

**MATERIALS:**

1. A template sheet for fins (make reproduction for class or squadron on a copy machine)
2. One foam meat tray
3. One pipe insulation tube cut to a length of 14" (Note foam pipe insulation tubes come in five foot lengths. You can get 4 rockets from one tube. For a class of 30, you will need 8 tubes.

- The cost varies, but the average is around \$1.00 per tube.
4. One hot glue gun
  5. One snap knife to cut foam
  6. One or two cable ties
  7. One #64 rubber band
  8. One soda straw

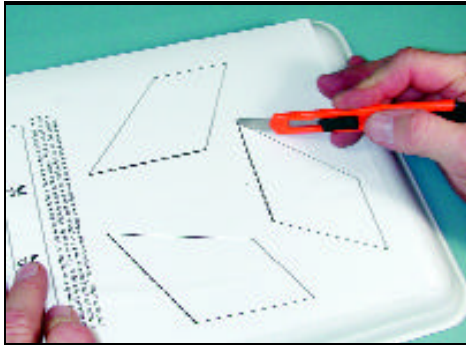

**PROCEDURE:**

Position the template on the foam meat tray and cut out the fins using a snap knife.



The fins may be left as is or sanded to round the edges for a more aerodynamic shape.

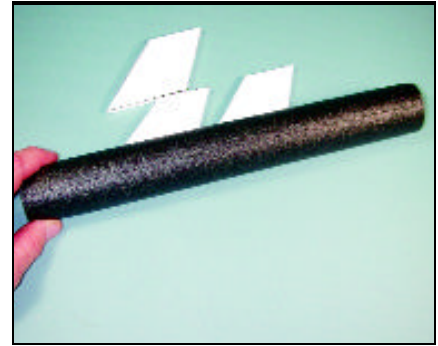

Cut a piece of pipe insulation to a length of 14".

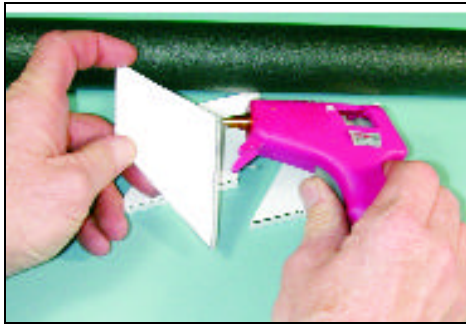

Apply hot glue to the edge of the fin, not to the pipe foam.

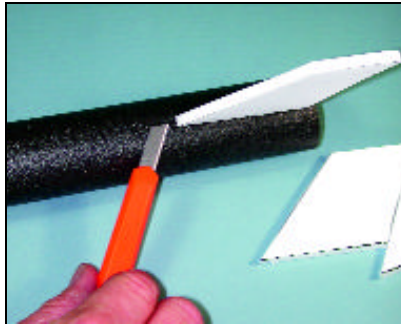

Place the fin on the pipe covering seam. This seam acts as a positioning guide.



Wrap the fin guide around the pipe foam as shown. Wrap it around the tube so that it ends at the seam. Secure with tape.



The small arrows show the builder where the other fins are to be mounted.

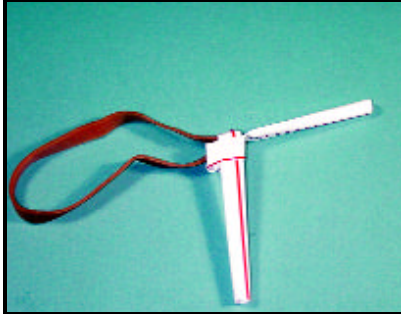

You are now ready to work on the power source. Tie a soda straw or a cable tie around a #64 rubber band.



Stuff the soda straw ends into the nose of the foam tube so that some of the rubber band sticks out.



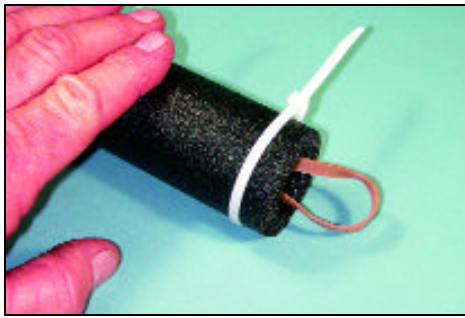

Wrap a cable tie around the opening about 3/8" from edge as shown. Notice how much of the rubber band is showing out the end of the tube.

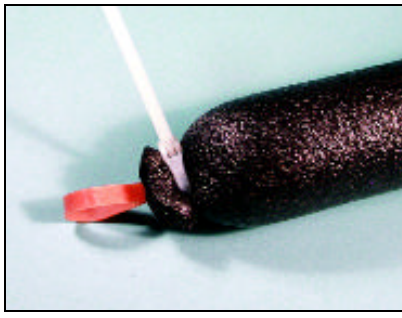

The cable is cinched down with force. Make it tight.



Trim the tail off the cable tie. Make sure that no sharp edges remain.



A big blob of hot glue is squeezed on to the cable tie head to add a measure of safety to the construction.

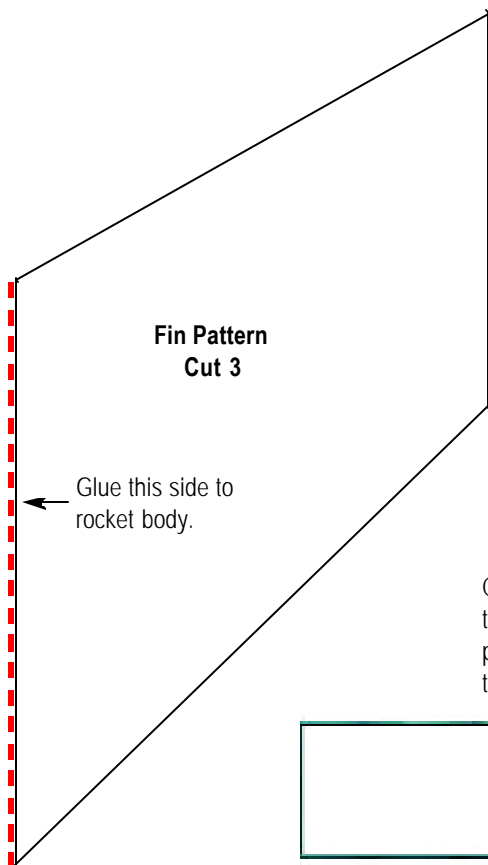
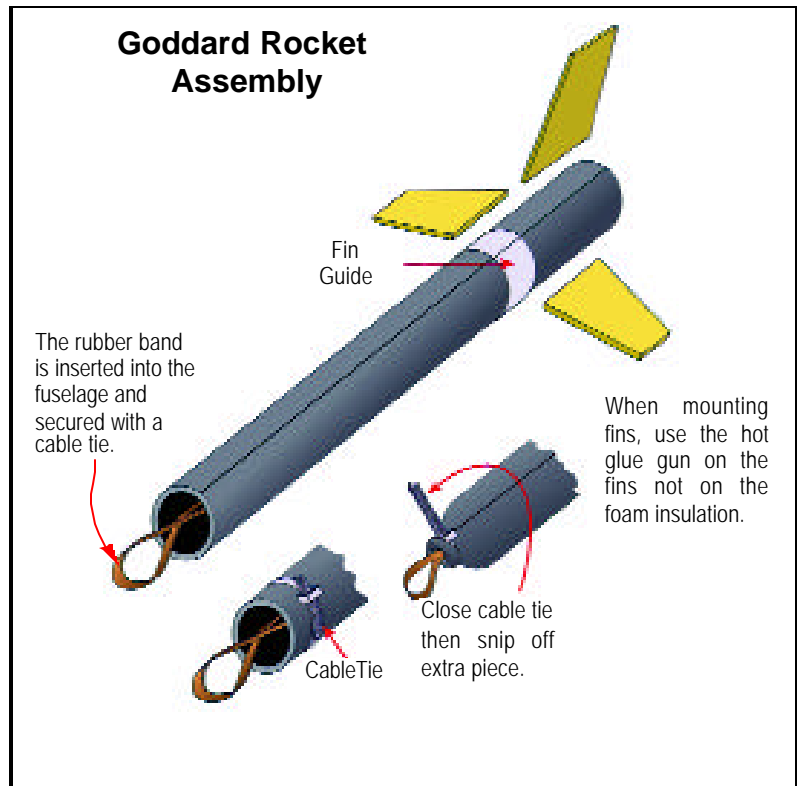

### To Launch the Rocket

1. Put one thumb into the "tailpipe" and hold the tail firmly.
2. Put the other thumb into the rubber band.
3. Stretch the rubber band to about 4".
4. When you launch the rocket, pitch it forward in a slight arc. This adds just a small amount of thrust and makes the rocket fly straighter.

Copy the guide in the diagram below, then wrap it around the pipe foam tube a little more than 3" from the rocket's tail pipe. The two ends should meet at the seam. Put a small piece of tape on this guide to hold it in place. Hot glue one rocket fin on to the seam of the foam tube. The arrows show where the other two fins should then be mounted.





# REDSTONE

## Hands-on Option Three

### JUNK ROCKETS



Your "junk" includes filing folders, meat trays, drinking cups, rubber bands, pipe foam insulation, Styrofoam™ Easter eggs, film cans, toilet paper cylinders, paper towel cylinders, white glue and index cards. Can you build a great rocket from these materials?

**OBJECTIVE:** Using only common household items, cadets can create a rocket that has a propulsion system.

**MATERIALS:** The Challenge: the builder can only use common household paper, foam and plastic items. There can be no fire or explosions. The image above shows a few allowable items.

## AN EXAMPLE: THE T.P. TORPEDO

The "T.P. Torpedo!" is made from a toilet paper cylinder, a drinking cup, one rubber band, a drinking straw and the fins are made from index cards. In test flights, this "junk rocket" went more than 60 feet! Not a bad performance for a freebie!

### MATERIALS:

1. The "T.P." part of this activity is a cylinder from a roll of toilet paper.
2. The "propulsion" mechanism will be a rubber band that is secured inside a cone-shaped drinking cup.
3. The drinking cup will be attached to the top of the toilet paper cylinder.
4. Fins are made of index cards and attached to the toilet paper cylinder.



The very tip is cut off of a cone-shaped drinking cup as shown.



A piece of soda straw is bent over and taped to a #64 rubber band.



The rubber band is drawn through the hole in the cup.

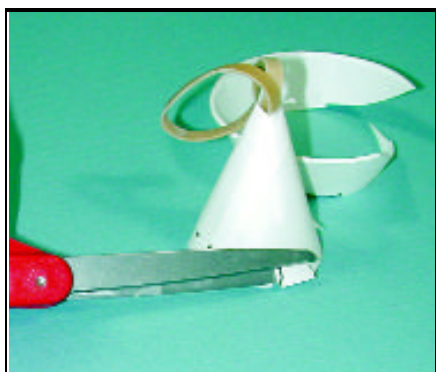

The cone is now cut so that it fits the top of the toilet paper cylinder.

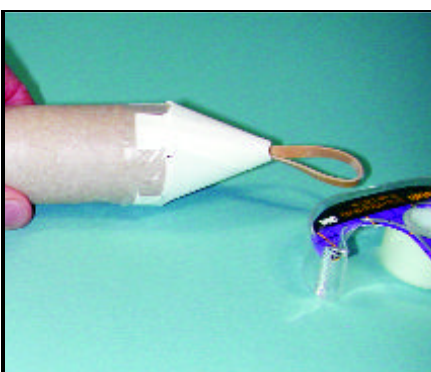

Cut small tabs into the cup so that it may be taped to the t.p. cylinder.

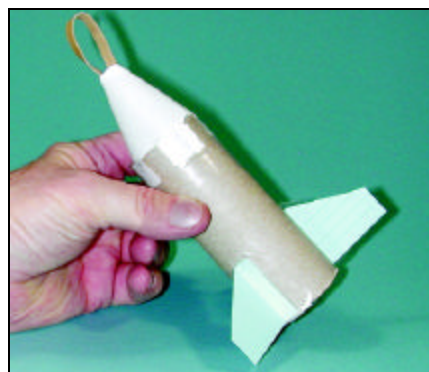

Fins like these can be cut from index cards and taped to the cylinder. Voila! "T.P. Torpedo," a Junk Rocket!

**To launch**, put one thumb in the tail pipe of the cylinder, stretch the rubber band with the other and let go.

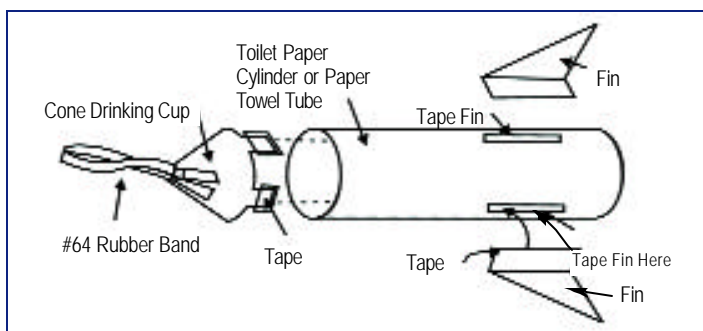
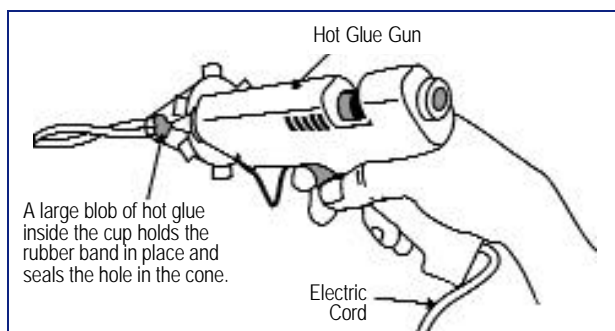



# REDSTONE

## Hands-on Option Four

### POP BOTTLE ROCKETS



**Pop Bottle Rocket Mounted On Versey Launcher**

The launcher shown in the photograph can be purchased by contacting Wayne Versey, Versey Enterprises, 1258 N. 1100 East, Shelly, Idaho 83274. The phone, as of this publication, was 1.208.357.3428.

**OBJECTIVE:** To introduce cadets to an inexpensive, high powered rocket that can be launched again and again at virtually no cost!





After countless teacher workshops and CAP activities, it has been found that the standard Pepsi™ and Coke™ two-liter bottles seem to work the best.

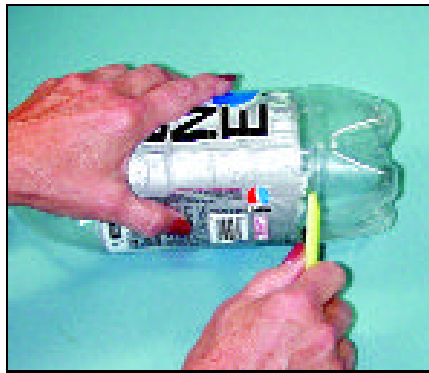

**PROCEDURE:**

You will be adding weight to the rocket to make it come straight back down.  
Cut off the bottom of one of the two-liter bottles. The bottoms of the bottles must be identical.



The idea is to mount several washers to the top of the bottom of a pop bottle. The bottom of the bottle will become the top or nose of the rocket. To do this, washers are going to be duct-taped to a rocket bottle and secured with a cap from another pop bottle.



The washers are positioned as shown on top of the rocket bottle.



The bottom cap that you removed from the other pop bottle is now placed over the washers and duct-taped to the rocket bottle.

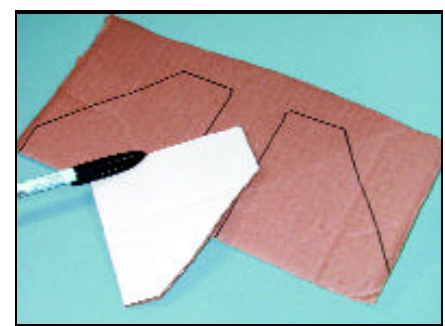

Fins can be made from just about anything; however, cardboard works very well and takes the abuse of repeated flights.



The fin pieces are split about 1" up from the bottom as shown. A snap knife works well for this task.



The reason for the splitting of the fin can be seen here. Each "flap" is used to secure the fin in place on the rocket bottle. Duct tape works very well for this mounting.

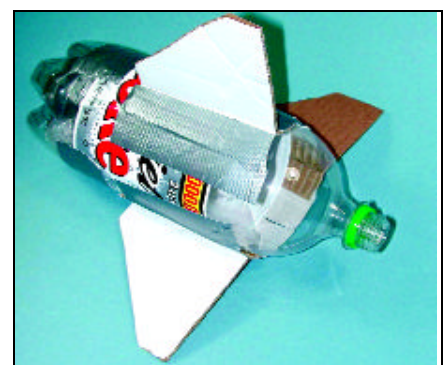

Here's your completed pop bottle rocket. To make it fly, add a little water, mount it on a launching platform, secure it with a pin, add a little pressure (start out small and work upward in pressure) then pull the pin.

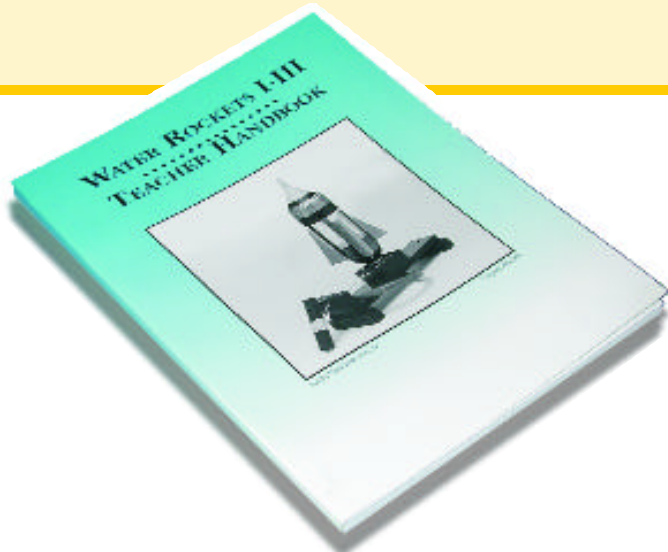
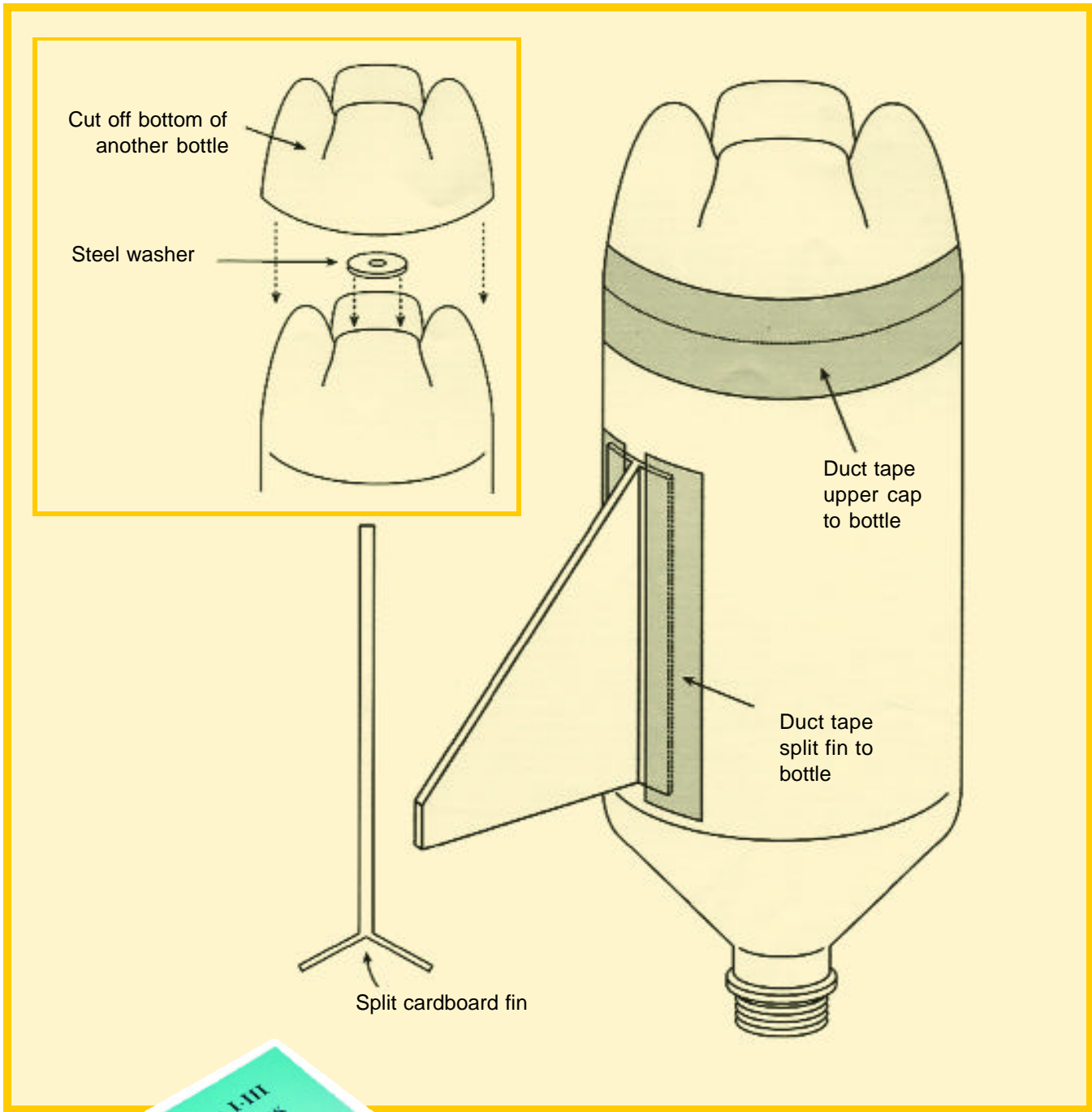

***Water Rockets I-III  
Teacher Handbook,***  
a highly recommended guide is  
available from Pitsco. See page 78  
for address and toll free number.



# REDSTONE Optional Project

**NOTE:** This is an option for the Pop Bottle Rocket builder. This does not count as one of the Redstone Hands-On Options. It is only a suggested project that can be used in the launching of pop bottle rockets.

## SCRATCH-BUILDING A POP BOTTLE ROCKET LAUNCHER

The author highly recommends *Water Rockets I-III Teacher Handbook*. This outstanding guide book was written by two highly-qualified science teachers from the Lincoln, Nebraska area. The authors, Jake Winemiller, of Lincoln Southeast High School, and Ronald J. Bonnstetter, University of Nebraska, Lincoln, have produced a very detailed publication that will guide the cadet through the science and technology of bottle-rocket flight. Their manual contains information on how to build and fly bottle rockets from a beginner version up through computer-engineered, multi-stage launches! The text is available through PITSCO, an

educational supply company based in Pittsburg, Kansas. Their toll-free number is 1-800-835-0686.

The author has tried numerous pop bottle rockets and launchers and found one of the best for everyday use is the one in the Winemiller-Bonstetter book. Permission has been granted from Insights Visual Productions, Inc., to feature this launcher in the Civil Air Patrol Model Rocketry program. Instructions for the creation and assembly of the launcher may be found on Pages 94-97 of the *Water Rockets I-III Teacher Handbook*.

### MATERIALS:

#### WOOD:

1. (1) 1" x 4" x 16" Plywood, or other hardwood, that will become the base launching platform.
2. (2) 2" x 2" x 6" wooden blocks. These become the wood supports (legs).
3. (1) 2" x 3" x 4" wooden block. This is the stop block that keeps the U-shaped retainer pin from flying off the pad.
4. (1) 1" x 1" x 6" piece of wood, or a large dowel rod 1 inch in diameter, is needed for a handle.

#### HARDWARE:

5. (1) Electrical box that is approx. 4" x 4" x 1 1/2" high. It is recommended that you use one that has two holes on each side. If you study the illustration of the basic launch pad, you will see how the steel rod (launch pin) is inserted into these holes.
6. (1) 1 foot of 3/16" steel rod. This is formed into a "pin" that secures the rocket to the electrical box.
7. (4) 1" Flat head wood screws to fasten legs to bottom of launcher.
8. (2) #10 wood screws for fastening the electrical box to the launch platform.
9. (2) 2" (#10) flat head wood screws for mount-

ing the stop block.

10. (2) 1/2" (#8) wood screws to hold the conduit strap (1/2" EMT) to the launch pad.
11. (1) 10" x 1/2" nail to anchor the launcher to the ground.
12. (1) Large metal washer with a 5/8" hole in the center.
13. (1) 5 foot length of 5/8" inside diameter garden hose.
14. (2) Hose clamps to hold the garden hose to the PVC elbow and the valve stem.
15. (1) PVC elbow. This should be the 90° ribbed kind that has a 1/2" inside diameter.
16. (1) Conduit strap (1/2" EMT strap) to hold the elbow and hose to the launch pad.
17. (1) 10 foot length of 1/8" nylon cord to pull the launch pin.
18. (1) 9/16" cone washer. This washer provides the seal between the rocket and the PVC elbow. If you can't find one this large in a regular hardware store, they can be ordered.
19. (1) Large valve stem. These can be found at tire stores. It is shown in the illustration of the "Pressure hose assembly" on page 24.

#### TOOLS:

20. Hand or electric saw.
21. Electric drill.



- |                                 |                   |
|---------------------------------|-------------------|
| 22. Drill bits, 5/8" and 7/32". | 25. Hammer.       |
| 23. Dremmel tool.               | 26. Broom handle. |
| 24. Hack saw.                   |                   |

## LET'S BUILD IT!

### PROCEDURE:

- Using a saw, cut a piece of 3/4" to 1" plywood to a 1" x 4" x 16". If you look around, places like Home Depot will often have scraps that are free. In some instances, they will even cut the piece if you tell them you are doing a CAP project in rockets!
- Your electrical box will have two holes pre-drilled on each side. Ream out four of these holes (two each on opposite sides with a 7/32" bit.) These holes will be used to secure the U-shaped retaining pin made from the 3/16" rod.
- Drill a 5/8" hole in the middle of the base. The hole should be approximately 7" from one end. Enlarging this opening slightly with a Dremmel tool will allow for easier assembly.
- Using a hack saw, cut a 12" length of the 3/16" diameter rod. Bend the rod around a broom handle. That makes a nice "U" shape. Now test it in the electrical box so that slides easily in all four holes as shown in the illustration.
- Attach the legs to the bottom of the launch pad using 1" wood screws.
- A large nail will be used to hold the launcher to the ground. A 1/2" to 5/8" hole should be drilled in one of the elevation blocks to hold the nail when not in use.
- Attach a stop block into position as shown in the illustration. It will take two 2" screws to keep it secured to the launch pad. A 7/32" inch hole should be drilled into this stop block so that the nylon pull cord can be attached to the U-shaped retaining pin and a handle on the other end.
- Punch out the center hole of the electrical box. Attach it to the base platform so that the hole in the bottom of the box is over the 5/8" opening. Also make sure that the holes for the retaining pin are aligned as shown in the illustration. Use two 3/4" #10 wood screws to secure the electrical box to the launch platform.
- Drill an additional 5/8" hole in the opposite end of the pad from the stop block. This will be an anchor hole and will go all the way through the pad. A large nail goes through this hole and secures the pad to the ground during launch.
- Using something like a liquid detergent, lubricate the inside of the ends of your garden hose piece.
- Slip the PVC elbow into one end of the garden hose and secure it with a hose clamp as shown in the illustration.
- Place the large end of the valve stem into the other end of the hose. Place the hose clamp slight ahead of the valve stem bulge and then tighten. This is essential to stop the valve stem from being blown out of the hose as pressure is added.
- Place the PVC elbow through the 5/8" air inlet hole in the base platform. You may have to tap it in with your hammer. Secure the elbow with the 1/2" Conduit strap and wood screws (#8 wood screws).
- Add one or two 5/8" metal washers, then slip the cone gasket over the end of the PVC pipe.

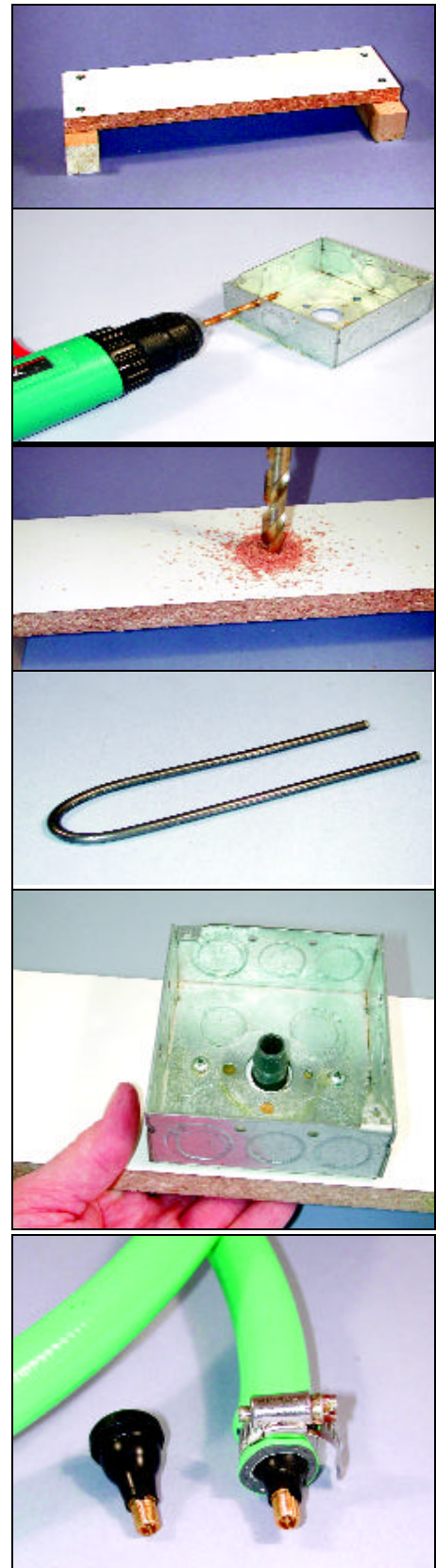



15. Drill a 7/32" hole through the center of the handle and thread the cord through this hole. Knot it. Slip the cord through the hole in the stop block and tie the other end to the "U-shaped" retaining pin.
16. The cone washer is mounted over the elbow and when in position, will seal the pop bottle. The retaining pin will keep it from moving while pressure is applied.

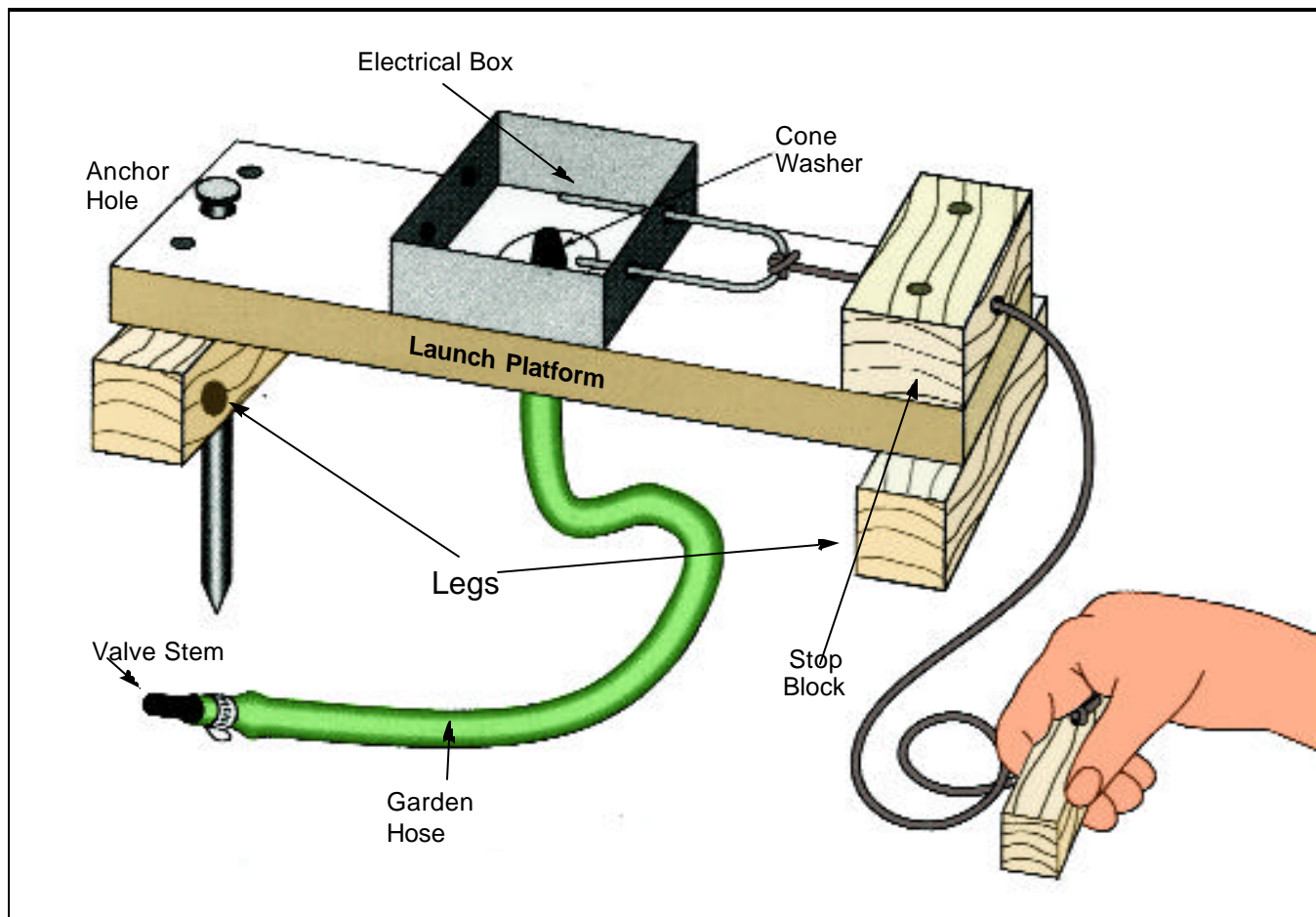
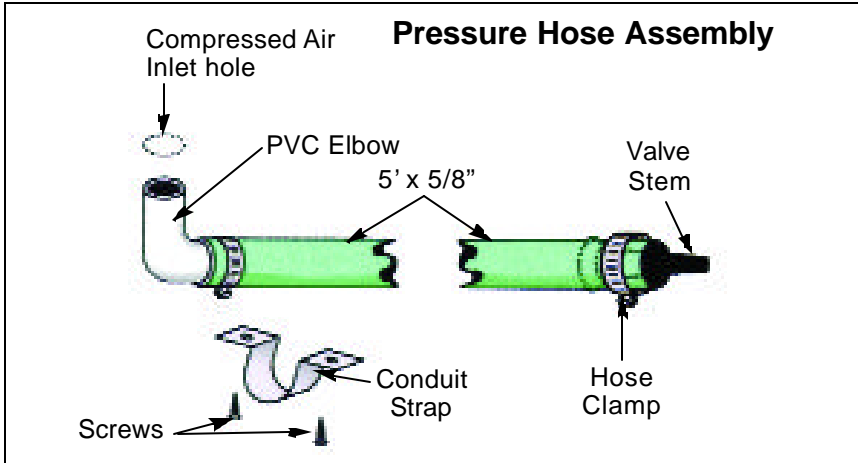
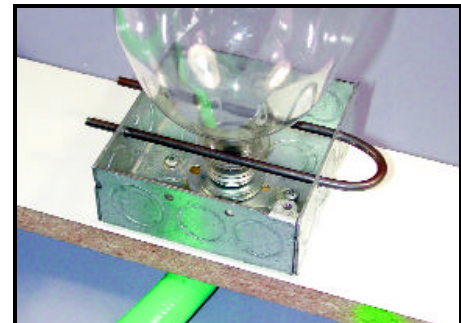
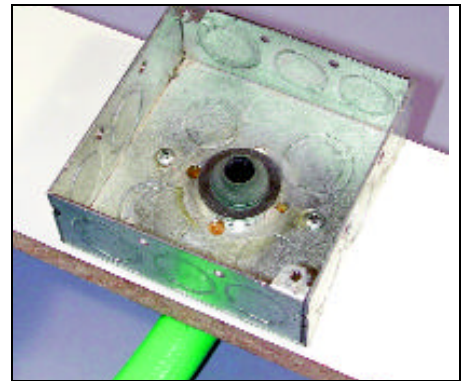

Permission to use the features of these illustrations granted by Insights Visual Productions, Inc.



# REDSTONE

## Official Witness Log

### HANDS-ON PHASE

When a cadet completes the written examination, he/she is required to have a Qualified Senior Member (QSM), witness the successful launch of TWO non-solid fuel rockets with alternate sources of power. After witnessing the successful flight of these rockets, the QSM must sign this Official Witness Log (OWL).

CADET \_\_\_\_\_

of \_\_\_\_\_

Squadron, has selected the following two rockets to build of the four listed below.

1. The Fizzy Flyer
2. The Goddard Rocket (a foam tube and rubber band rocket)
3. The Junk Rocket (a paper tube, rubber band, paper cup and fins model)
4. The Pop Bottle Rocket (a compressed air model using a one or two liter pop bottle for the main body of the rocket)

As the QSM, I have witnessed the successful flight of each of the chosen rockets.

\_\_\_\_\_  
STO/QSM



# **REDSTONE STAGE**

## **Squadron Commander's Approval**

I have reviewed the Official Witness Logs, both written and hands-on, of Cadet

---

and have found that this individual has successfully passed the Redstone Stage requirements and is now qualified to advance to the Titan Stage of the Model Rocketry Program of the Civil Air Patrol.

The cadet will be now be awarded a certificate of Completion of the Redstone Stage.

---

Squadron Commander